

-ill Word Family List

bill

grill

still

chill

hill

thrill

dill

ill

will

drill

mill

fill

pill

frill

sill

gill

skill

Name _____

ill Cut and Paste





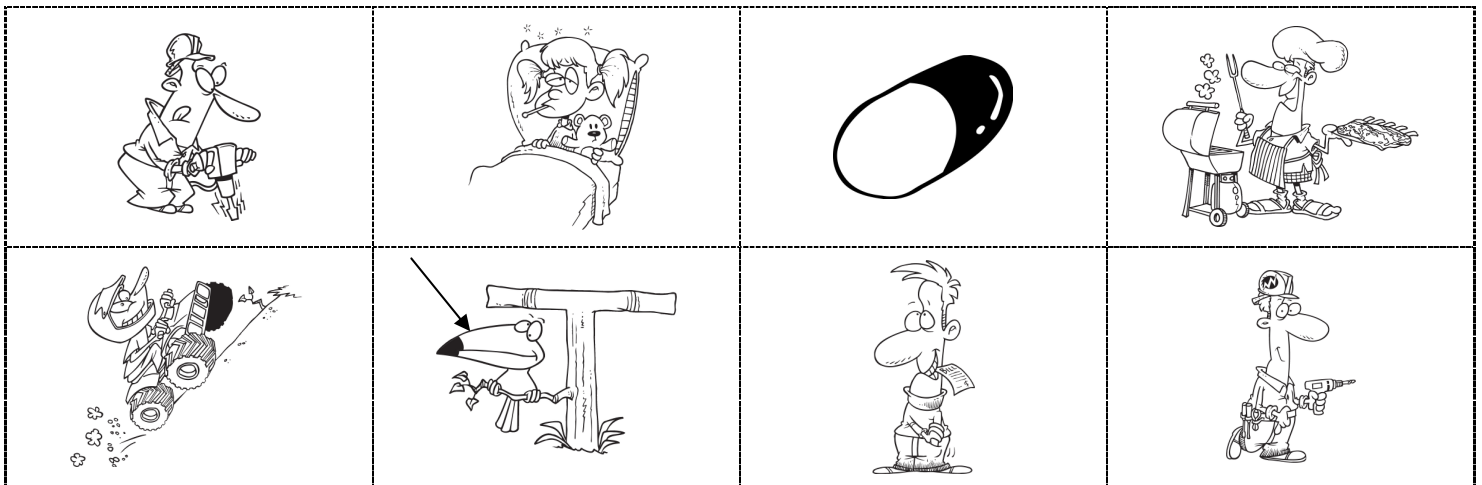

pill		ill	
grill		uphill	
drill		bill	
bill		drill	



Name _____

ill See, Say, Spell and Write



	<hr/> <hr/> <hr/>
	<hr/> <hr/> <hr/>
	<hr/> <hr/> <hr/>
	<hr/> <hr/> <hr/>
	<hr/> <hr/> <hr/>
	<hr/> <p>pill</p> <hr/>

Name _____

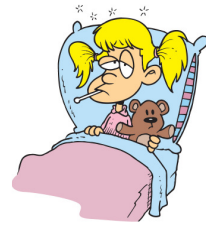

Say the name of each picture. If the picture belongs in the -ill family and rhymes with ill, add -ill to finish writing the word.



b



ch

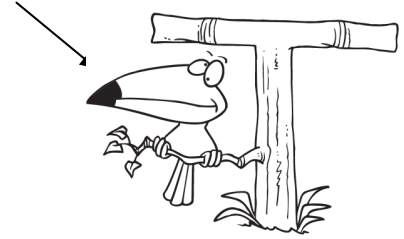

b





dr



sp

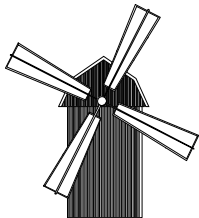

m



l



dr

Name _____



Look at the picture in each box. Circle the word that matches the picture. Write the word on the lines.

1.



spill
spell

2.



drink
drill

3.



ill
all

4.



greet
grill

5.



bill
bell

X's and O's



Directions for teacher/parent: Students circle each picture that ends with the -i// rime. They make an x on each picture that does not end with the i// rime.

More X's and O's

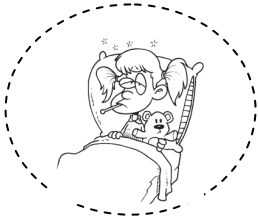

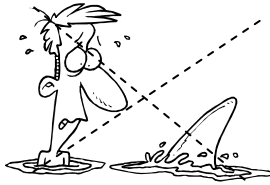



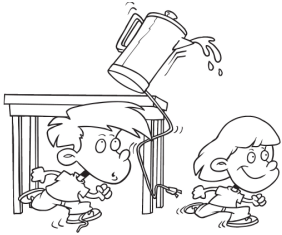



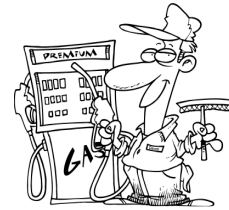



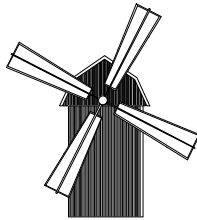



Directions to teacher/parent: Students circle each picture that ends with the -ill rime and write the word in the box. If the picture does not end with the -ill rime, students make an x over the picture.

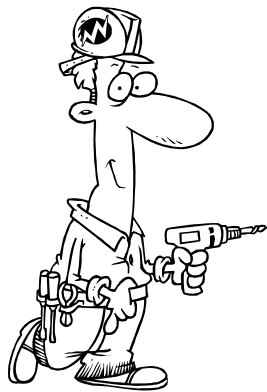

Cloze the Gap! (ill)

Read the following sentences, saying the word "drill" when you come to a blank space. Use words from the *ill* family to fill in the blanks and make sense. Reread your sentences to double check your choices!

1. Mom, may I have a dollar _____ for the field trip?
2. Dad likes to _____ hotdogs on the barbecue.
3. We take a vitamin _____ every morning.
4. _____ you help me with my homework?
5. When I'm too wiggly, my mom says, "Be _____!"
6. Jack and _____ went up the hill to fetch a pail of water.
7. I love _____ pickles on my hamburgers!
8. The dentist had to _____ my tooth. Ouch!
9. A mountain is bigger than a _____.
10. Please don't _____ your drink in the car.
11. May I get a _____ on my soda?

Word Bank

bill Jill pill grill still
will dill hill drill spill
refill

Configuration Station (ill)

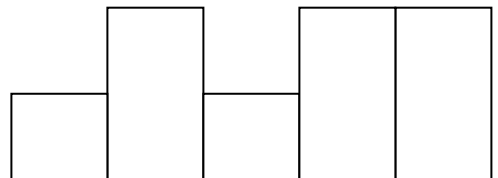
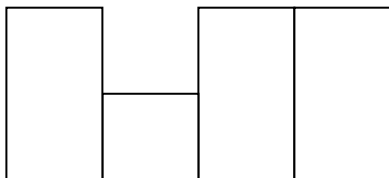
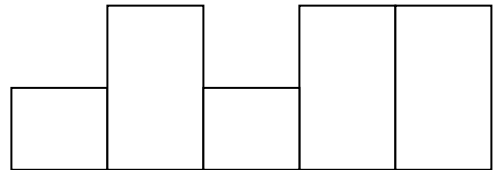
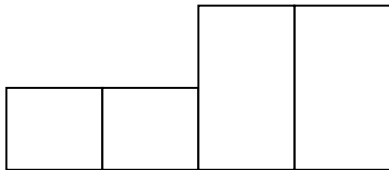
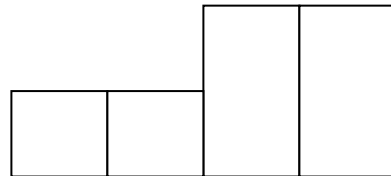
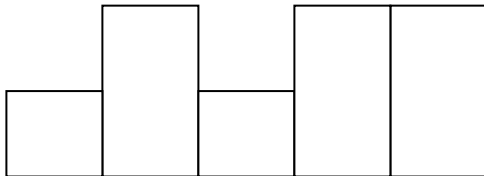
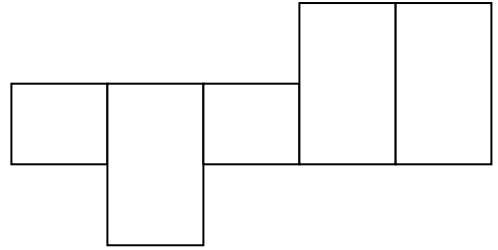
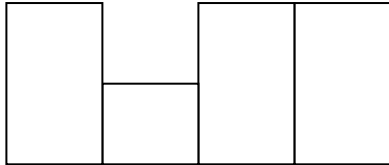
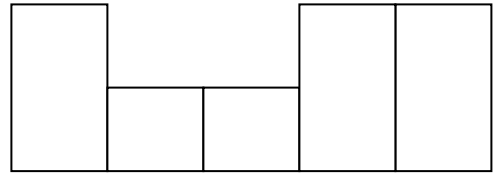
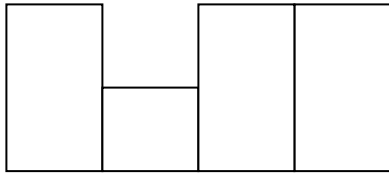

Word Bank			
skill	drill	hill	bill
still	spill	mill	fill
	chill	will	



Crossword Puzzle: ill



1				
3				
				4
		7		
	8			

2				
		5		6

Across

- dribble or drip
- make a hole with a tool
- sick or not well
- medicine

Down

- quiet or at rest
- a kind of pickle
- opposite of won't
- barbecue
- delight or excitement
- opposite of empty

Word Bank				
ill	will	pill	thrill	skill
dill	spill	drill	grill	fill

ill Word Search



g	r	i	l	l	a	b	i	l	l
i	j	o	e	k	n	q	u	o	v
l	a	s	k	i	l	l	e	t	j
l	n	p	q	v	o	x	a	i	k
a	k	i	j	c	h	i	l	l	n
f	i	l	l	e	i	q	k	l	o
r	o	l	n	m	l	v	j	e	w
i	j	e	p	i	l	l	k	a	i
l	a	q	v	l	o	e	u	n	l
l	k	o	n	l	d	r	i	l	l

gill
grill
bill

spill
skill
pill

chill
drill
till

hill
fill
mill

will
frill

Score With Scrabble!

SCORE

B ₃	I ₁	L ₁	L ₁		
C ₃	H ₄	I ₁	L ₁	L ₁	
D ₂	R ₁	I ₁	L ₁	L ₁	
G ₂	R ₁	I ₁	L ₁	L ₁	
F ₄	I ₁	L ₁	L ₁		
H ₄	I ₁	L ₁	L ₁		
M ₃	I ₁	L ₁	L ₁		
P ₃	I ₁	L ₁	L ₁		
S ₁	K ₅	I ₁	L ₁	L ₁	
S ₁	P ₃	I ₁	L ₁	L ₁	
T ₁	H ₄	R ₁	I ₁	L ₁	L ₁
Total					

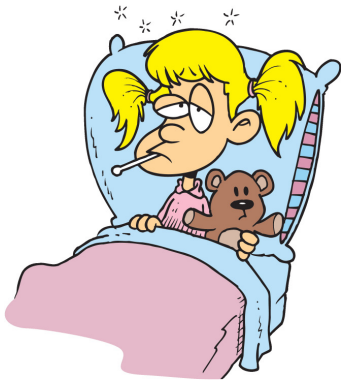

Alphabet Avenue

Place the words below in alphabetical order.

1		7	
2		8	
3		9	
4		10	
5		11	
6		12	

WORD BANK					
grill	will	chill	hill	mill	drill
dill	ill	fill	spill	gill	bill

Simple Sentences (ill)

Word Bank

grill

spill

ill

chill

Name _____

Read each sentence below, saying the -ill picture names as you read. Rewrite the sentence and change each picture to a word. Illustrate the sentences on the back of your paper.

1. Jill, please don't  the milk!

2. Bill works at a Bar-B-Q  .

3. Phil got a  and then he was 

ill Partner Puzzle

pill



bill

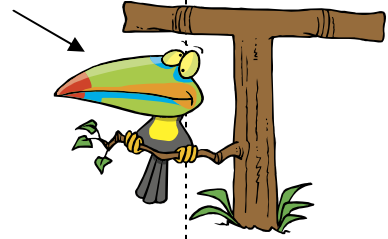

drill



mill

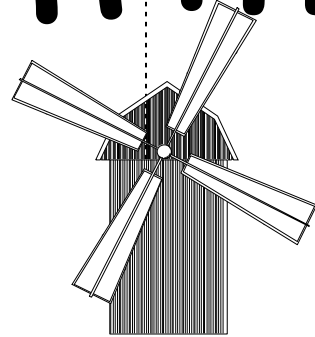

grill

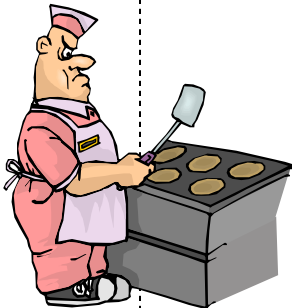

spill



i | |



sp | |



gr | |



p | |

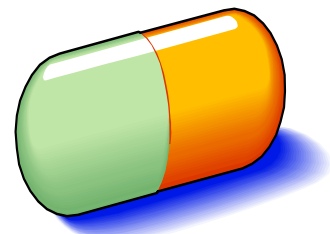

chill



mill

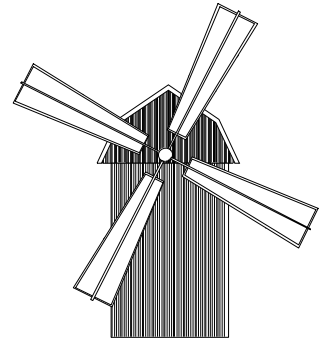

dill

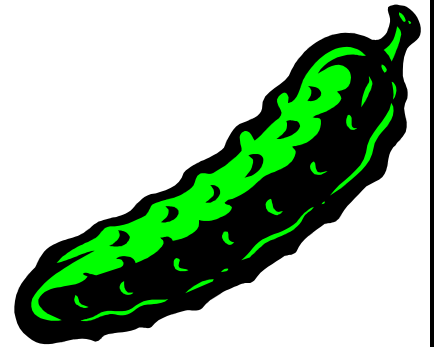

drill



bill

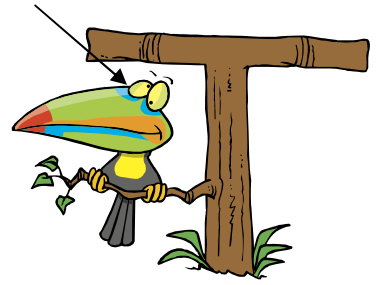

bill



uphill



downhill



ill Words and Pictures for Sorts and Stuff

-ill Pictures and Words



-ill Pictures and Words

ill

-ill Pictures and Words



-ill Pictures and Words

spill

-ill Pictures and Words



-ill Pictures and Words

grill

-ill Pictures and Words

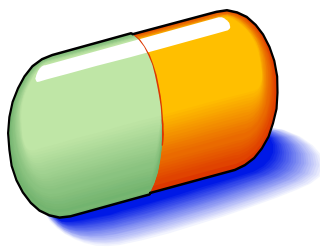

-ill Pictures and Words

pill

-ill Pictures and Words



-ill Pictures and Words

chill

-ill Pictures and Words

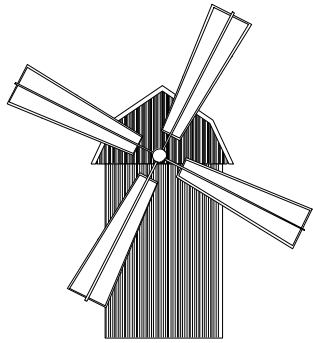

-ill Pictures and Words

mill

-ill Pictures and Words

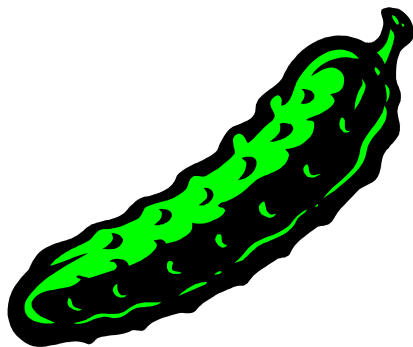

-ill Pictures and Words

dill

-ill Pictures and Words



-ill Pictures and Words

drill

--ill Pictures and Words

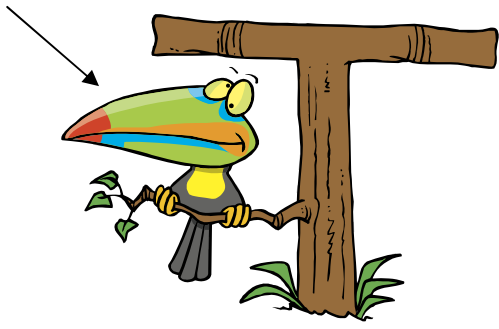

--ill Pictures and Words

bill

--ill Pictures and Words



--ill Pictures and Words

uphill

--ill Pictures and Words



--ill Pictures and Words

drill

--ill Pictures and Words

--ill Pictures and Words

ill Family Word Slide

ill



ill Family Word Slide
(Sound Blending)

Print on vellum, cut, and laminate for durability. Cut the top and bottom slits to the left of the rime chunk for the slide. Model proper use for students: blending to form and say new words.

b

ch

d

dr

f

fr



g

gr

h

J

m

p



d

dr

sk

sp



st

w

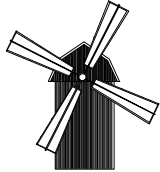
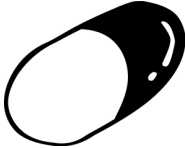

What's it Worth? (-ill)

(cut, spell, glue and add)

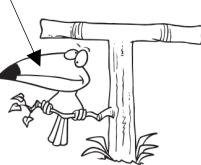
			i 1	l 2	l 2	
						
						
						
						

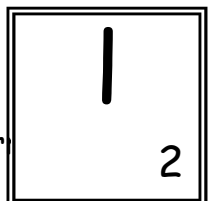
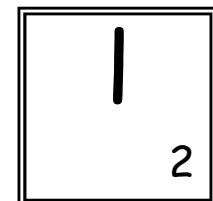
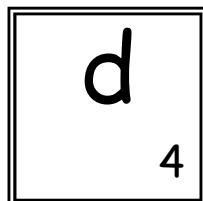
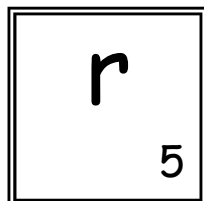
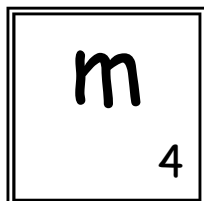
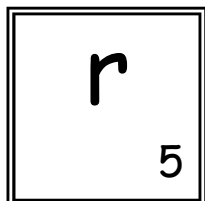
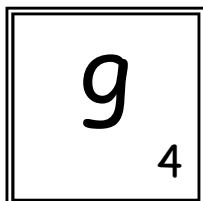
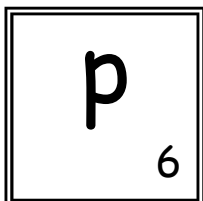
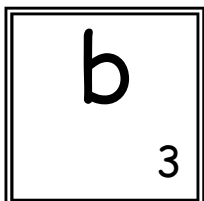
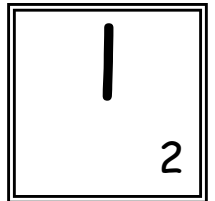
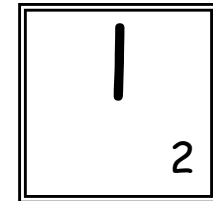
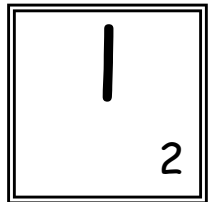
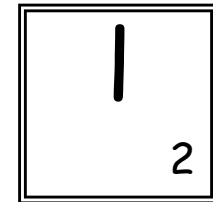
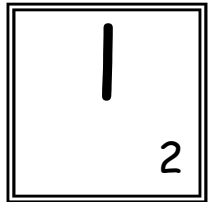
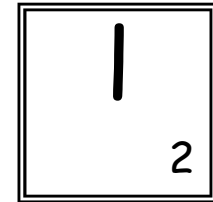
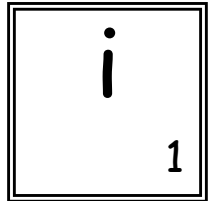
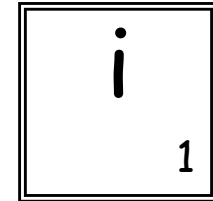
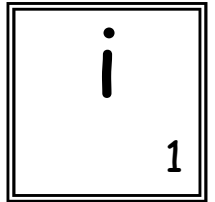
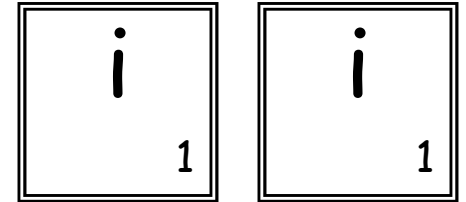

er

Say the name of each picture. Read the words and circle the word that names the picture. Write the word underneath the picture. Make a picture for the last three words. You may need to use the dictionary.



pile

spill



drill

doll

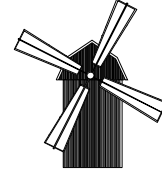

mill

mile



gill

grill

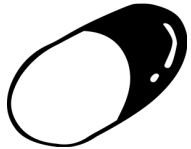

poll

pill

chill

fill

bill



My ill Book



My ill Book



ill Family Stationery

bill, chill, dill, drill, fill, frill, gill, grill, hill, ill,
mill, pill, sill, skill, still, thrill, will

Write sentences or a story with -ump words of your choice.

Handwriting practice lines consisting of solid top and bottom lines with a dashed middle line. There are five sets of these lines provided for writing.



ill

ill

ill

ill

ill

ill